

D200neo

AC/DC Multi-Function Smart Charger

Instruction Manual

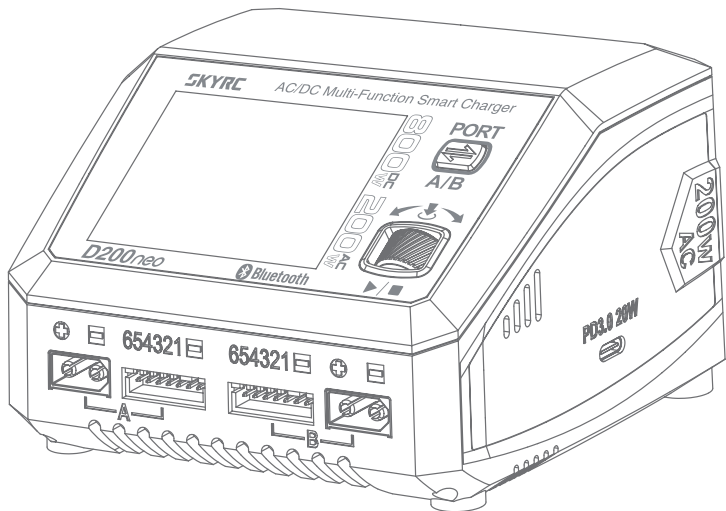

SKYRC

SK-100196

V1.2

Introduction	1
Package	1
Chart	2
Specification	2
Warning	4
Standard Battery Parameters	5
Program Flow Chart	6
Explanation of Buttons	8
Power and Battery Connection	9
Charger Operation	10
Lithium Battery Program(LiPo/LiFe/Lilon/LiHV)	12
Parallel Charge(LiPo/LiFe/Lilon/LiHV)	13
NiMH/NiCd Battery Program	14
Pb Lead-Acid Battery Program	15
External Discharge	16
Charger Master	17
Battery Analyzer	18
SkyCharger app Control	19
DC Power	19
PCH-150 Power & Charging Hub	20
USB Type-C PD/QC3.0 Output	20
Charging Settings	21
System Setting	22
Errors and Warnings	24
Firmware Upgrade Notice	25
Optional Parts	26
Conformity Declaration	27
Warranty and Service	28

Introduction

Congratulations on your choice of SkyRC D200neo AC/DC Multi-Function Smart Charger. As an update version of D200, this charger will take you on an exciting and delightful journey in the world of model aircraft.

D200neo has independent dual ports and supports most batteries in the RC industry. As a dual input charger, it can be used for various charging scenarios. We do not only inherit the meticulously designed interface and powerful functions of T1000 but also add the SkyCharger App control, Chager Master control enabled by Windows/MacOS and also PD/QC3.0 fast charge. So it can meet the charging requirements of different users for different scenarios in a great extent. The new appearance design and the newly upgraded scroll button control make the charging operation more convenient and simple.

For first-time use, please read the instructions, warnings, and safety tips carefully. Incorrectly charging a battery or using the charger in the wrong way can cause a fire or explosion.

Wishing you a pleasant experience with this charger.

Package

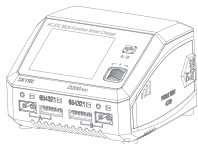

SkyRC D200neo charger*1



User Manual*1

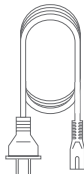

AC power Cord*1

Chart

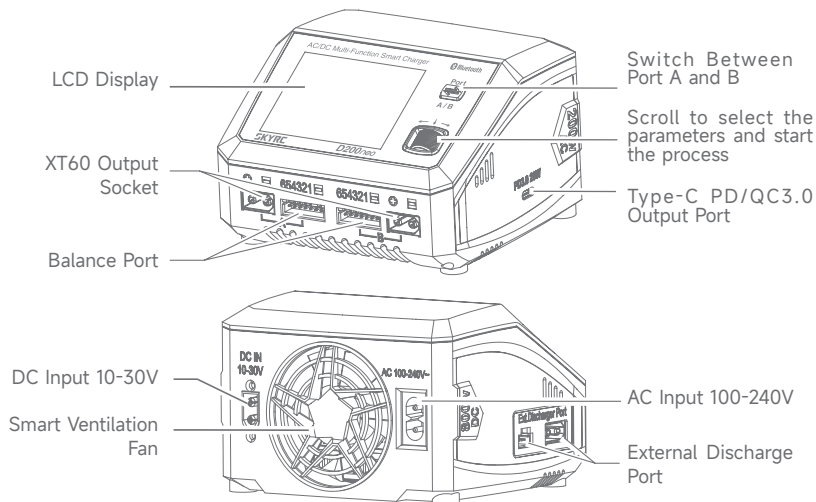

Specification

Item	Option	Specification
Model		D200neo
Input Voltage	AC	100-240V (50/60Hz)
	DC	10-30V
Input Current		30.0-35.0A

Item	Option	Specification
Charge Power	AC	200W MAX
	DC	400W*2 MAX
Discharge Power	Main port	10W*2
	Balance port	37W MAX
	External discharge	350W MAX
Charge Current	LiPo/LiFe/Lilon/LiHV/ NiMH/NiCd/Pb	0.1-20.0A
	Parallel	20-35.0A
Discharge Current	LiPo/LiFe/Lilon/LiHV/ NiMH/NiCd/Pb	0.1-2.0A
	External Discharge	0.1-40.0A
Balance Current	LiPo/LiFe/Lilon/LiHV	1.5A MAX
Battery Types	LiPo/LiFe/Lilon/LiHV	1-6S
	NiMH/NiCd	4-15S
	Pb	3S/6S/12S
Working Modes	LiPo/LiFe/Lilon/LiHV	Balance CHG, Charge, Discharge, Storage, Parallel
	NiMH/NiCd	Charge, Re-Peak, CYCLE_C_D, CYCLE_D_C, Discharge
	Pb	Normal, AGM Charge, Cold Charge, Discharge
DC Power Supply	Voltage	5-27V
	Current	1.0-15.0A
USB Type-C Output	QC3.0	5V=3A, 9V=2A, 12V=1.5A 18W
	PD	5V=3A, 9V=2.2A, 12V=1.67A 20W
Size	Length*Width*Height	116*110*79mm
Weight	Net weight	602g

Warning

D200neo is not intended for use by persons with reduced physical, sensory or mental capabilities, or lack of experience and knowledge, unless they have been given supervision or instruction concerning the use of the charger by a person responsible for their safety.

Failure to exercise caution while using this product and comply with the following warnings could result in a product malfunction, electrical issues, excessive heat, FIRE, and ultimately injury and property damage.

- ⚠ Never leave charging batteries unattended during use.
- ⚠ Never charge batteries overnight.
- ⚠ Never attempt to charge dead, damaged, or wet battery packs.
- ⚠ Never attempt to charge a battery pack containing different types of batteries.
- ⚠ Never charge batteries in extremely hot or cold places or place in direct sunlight.
- ⚠ Never charge a battery if the cable has been pinched or shorted.
- ⚠ Never connect the charger if the power cord has been pinched or shorted.
- ⚠ Never attempt to dismantle the charger or use a damaged charger.
- ⚠ Never attach your charger to both an AC and a DC power source at the same time.
- ⚠ Always use the charger with the correct charging and discharging program.
- ⚠ Always use only rechargeable batteries designed for use with this type of charger.
- ⚠ Never use the charger on car seats, carpets, or similar surfaces.
- ⚠ Always operate the charger away from flammable and explosive materials.

Standard Battery Parameters

	LiPo	Lilon	LiFe	LiHV	NiMH	NiCd	Pb
Nominal voltage	3.7V/cell	3.6V/cell	3.3V/cell	3.8V/cell	1.2V/cell	1.2V/cell	2.0V/cell
Max. charge voltage	4.2V/cell	4.1V/cell	3.6V/cell	4.35V/cell	1.5V/cell	1.5V/cell	2.4V/cell
Storage voltage	3.8V/cell	3.7V/cell	3.3V/cell	3.85V/cell	N/A	N/A	N/A
Allowable fast charge current	≤ 1C	≤ 1C	≤ 4C	≤ 1C	1C-2C	1C-2C	≤ 0.4C
Min. discharge voltage	3.0-3.3V/ cell	2.9-3.2V/ cell	2.6-2.9V/ cell	3.1-3.4V/ cell	0.1-1.1V/cell	0.1-1.1V/cell	1.8-2.0V/ cell

Select the correct operating procedure in accordance with the battery parameters.

Incorrect settings may cause the battery to burn or even explode.

Program Flow Chart



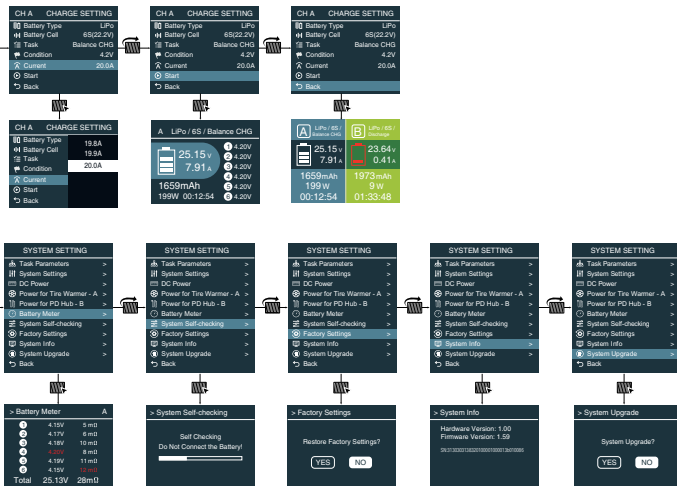

Note: The flow chart is taking one port for example as the flow chart for the two ports (Port A & B) are identical.

Explanation of Buttons

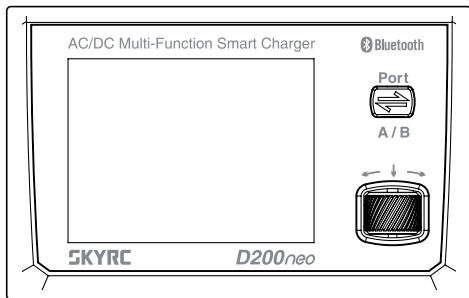

Port Switch Button

Switch Between Port A and B

Short-press to exit the system setting interface



Scroll Button

Short-press to enter the menu or confirm the setting

Scroll to select the menu or parameters

Press and hold for three seconds under main interface to enter into the system setting menu

Power and Battery Connection

1. Connecting to power source

There are two options of inputs for SKYRC D200neo, DC 10-30V and AC 100-240V.

AC 100-240V power source connection.

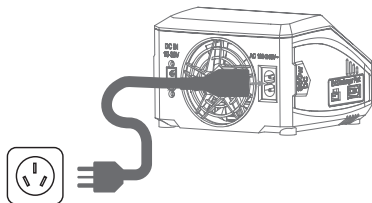

12V DC Battery / DC power supply connection.

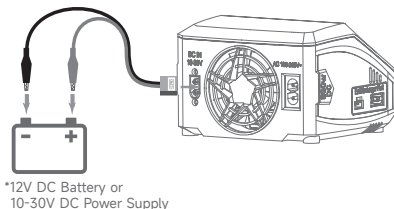

2. Connecting the battery



TO AVOID SHORT CIRCUITS, ALWAYS CONNECT THE CHARGE LEADS TO THE CHARGER FIRST, AND THEN TO THE BATTERY. REVERSE THE SEQUENCE WHEN DISCONNECTING THE PACK

1) LiPo Battery Connection with Balance Adapter

For safety reasons, it is highly recommended to charge Lithium batteries (LiPo, Lilon, LiFe and LiHV) using Balance CHG mode, unless the battery comes without a balance wire.

The balance wire attached to the battery must be connected to the charger with the black wire aligned with the negative marking. Ensure correct polarity!

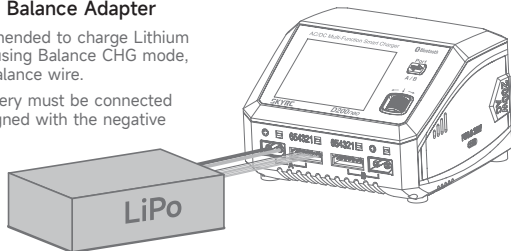

2) NiMH/NiCd or Pb Battery Connection

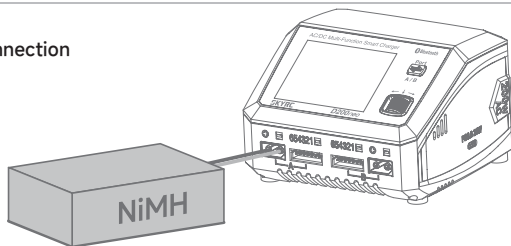

Charger Operation

Depending on battery type, different operations will be available. This chart shows which operations are available for the different types of batteries the D200neo is capable of working with.

Battery Type	Working Mode	Description
LiPo LiLo LiFe LiHV	Balance CHG	This mode is to balance charge the lithium battery based on the charging rate the user set. It can balance each cells of the battery.
	Charge	This mode is to charge the lithium battery based on the charging rate selected.
	Storage	This mode is to store the battery via charging or discharging its voltage to a specific storage value.
	Discharge	This mode is to discharge the lithium battery based on the discharging rate selected.
	Parallel	This mode is to parallel charge the battery with a higher charge rate of up to 35.0A.

Battery Type	Working Mode	Description
NiMH NiCd	Charge	This mode is to charge the NiMH/NiCd battery based on the charging rate selected.
	Re-Peak	In re-peak charge mode, the charger can peak charge the battery twice in a row automatically. This is good for confirming the battery is fully charged.
	Cycle_C_D	1 to 5 cyclic and continuous process of charge>discharge is operable for refreshing and restoring the performance of NiMH/NiCd batteries.
	Cycle_D_C	1 to 5 cyclic and continuous process of discharge>charge is operable for refreshing and restoring the performance of NiMH/NiCd batteries.
	Discharge	This mode is to discharge the NiMH/NiCd battery based on the discharging rate selected.
Pb	Normal	This mode is to charge the Pb battery based on the charging rate selected.
	AGM Charge	This mode is to charge the AGM battery based on the charging rate selected.
	Cold Charge	This mode is to charge the Pb battery under a low temperature based on the charging rate selected.
	Discharge	This mode is to discharge the Pb battery based on the discharging rate selected.

Lithium Battery Program(LiPo/LiFe/LiIon/LiHV)

The following flowchart is a reference to set the program manually.

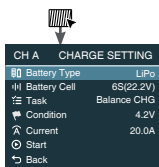

ENTER Charge Setting

On the main interface, press the scroll button to enter CHARGE SETTING.

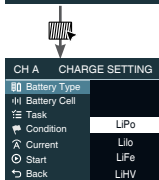

Battery Type Select

Press scroll button to call out the Battery Type menu, and scroll to select LiPo.

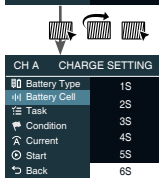

Battery Cell Select

Scroll to Battery Cell, call out the menu and scroll to select the correct battery cells.

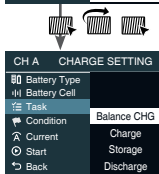

Task Select

Scroll to Task, call out the menu and scroll to select the working mode.

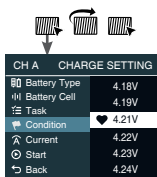

Condition Select

Scroll to Condition, call out the menu and set the delta voltage.

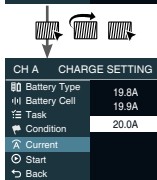

Charge/Discharge Current Select

Scroll to Charge/Discharge Current, call out the menu and scroll to select the working current.

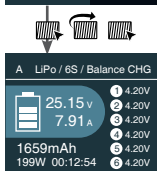

Start

Press scroll button to confirm and initiate the program.

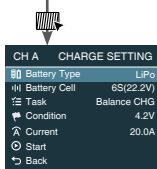

Stop

Press scroll button to stop the program.

Parallel Charge(LiPo/LiFe/Lilon/LiHV)

- The Parallel mode is available only for lithium batteries, which cannot be used for other types of batteries.
- To avoid short circuits, always connect the charge leads to the charger first, and then to the battery. Reverse the Sequence when disconnecting the pack.

1. Select the correct battery type (LiPo/LiFe/Lilon/LiHV);
2. Select the option of Parallel charge;
3. Select the charging current (20.0-35.0A);
4. Start the program after setting up;

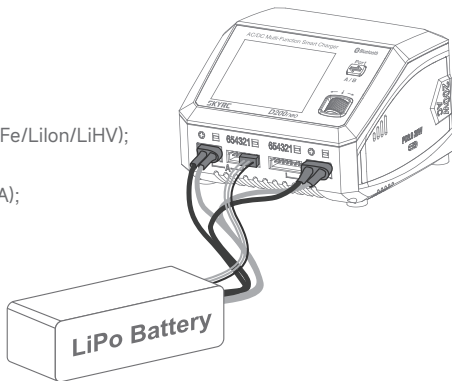

Notice:

- Ensure that AC and DC power is not connected simultaneously;
- With the single port, charging power is 200W; with the dual ports, charging power is intelligently distributed;
- Do not connect the battery before the charger powered on.
- The parallel charge cable is sold separately.

NiMH/NiCd Battery Program

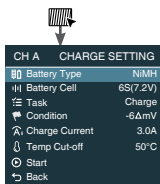

ENTER Charge Setting

On the main interface, press the scroll button to enter CHARGE SETTING.

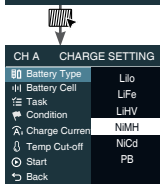

Battery Type Select

Press scroll button to call out the Battery Type menu, and scroll to select NiMH.

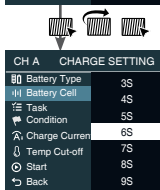

Battery Cell Select

Scroll to Battery Cell, call out the menu and scroll to select the correct battery cells.

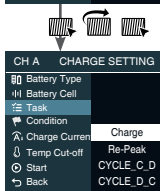

Task Select

Scroll to Task, call out the menu and scroll to select the working mode.

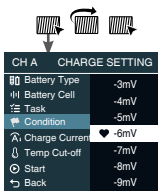

Condition Select

Scroll to Condition, call out the menu and set the delta voltage.

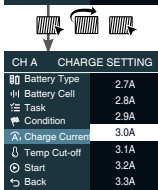

Charge/Discharge Current Select

Scroll to Charge/Discharge Current, call out the menu and scroll to select the working current.

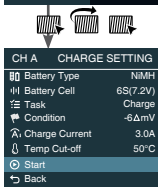

Start

Press scroll button to confirm and initiate the program.

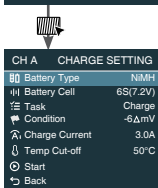

Stop

Press scroll button to stop the program.

Pb Lead-Acid Battery Program

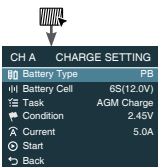

ENTER Charge Setting

On the main interface, press the scroll button to enter CHARGE SETTING.

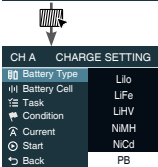

Battery Type Select

Press scroll button to call out the Battery Type menu, and scroll to select PB.

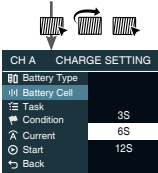

Battery Cell Select

Scroll to Battery Cell, call out the menu and scroll to select the correct battery cells.

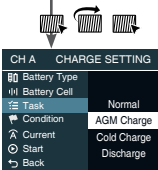

Task Select

Scroll to Task, call out the menu and scroll to select the working mode.

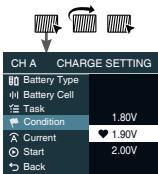

Condition Select

Scroll to Condition, call out the menu and set the delta voltage.

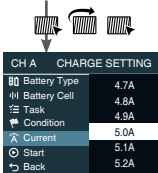

Charge/Discharge Current Select

Scroll to Charge/Discharge Current, call out the menu and scroll to select the working current.

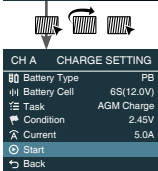

Start

Press scroll button to confirm and initiate the program.

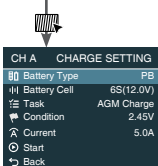

Stop

Press scroll button to stop the program.

External Discharge

D200neo is capable of external discharge. A discharge current of 40.0A can be reached with BD350 discharger connected.

1. Upon connecting the power supply, D200neo automatically powers up and enters the main interface;
2. Connect BD350 discharger to D200neo;

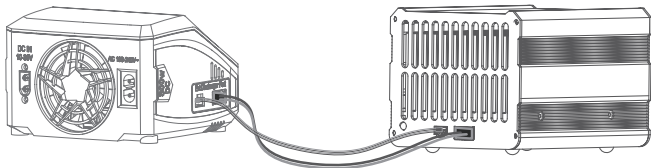

3. Connect the battery to D200neo on Port A;

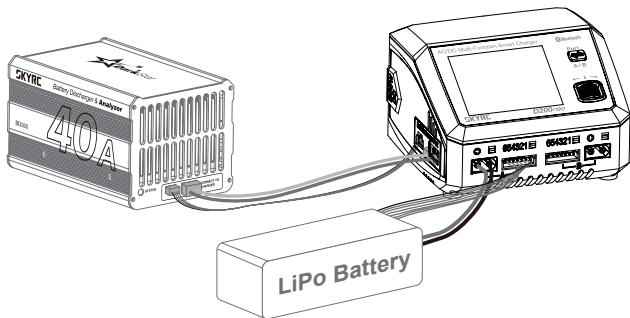

4. Select the battery type, battery cells, discharge program, cut-off voltage, and discharge current;
5. Start the program after setting up.

Notice:

- BD350 discharger is not included and must be purchased separately.
- External discharge is available only on Port A;

Charger Master

D200neo is capable of charging and discharging through the computer with both Windows/MacOS. Various parameters, including charge time and capacity, can be displayed visually, as well as charge current and voltage in a curve.

1. Download the latest Charger Master onto your desktop. Unzip and open it after downloading;
2. Power on your D200neo;
3. Connect D200neo to your computer via a USB type-C cable (It's recommended to select Data function under the USB menu in the system setting before connecting to PC.)

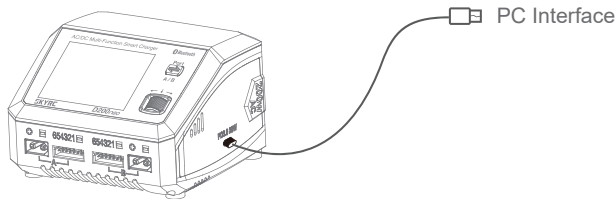

4. On the top left of the Charger Master, choose the option of Charge; Set the parameters on the corresponding ports. Click to start the program after setting up.

Battery Analyzer

D200neo is capable of analyzing the battery performance with BD350 discharger connected, helping players choose a more suitable battery for competitions and gain better achievements.

1. Launch the Charger Master and select Battery Analyzer on the top left;

Select →

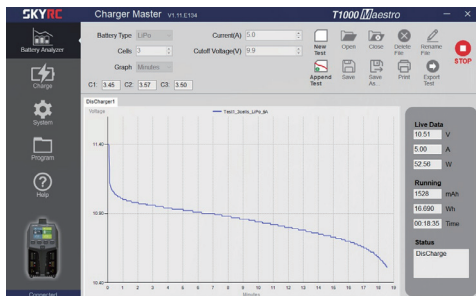

2. Specify the battery type, discharge current, cut-off voltage, and other parameters;
3. Click New Test to start the testing after setting up;
4. When the first test completes, click Append Test to start the second test. The third and further tests follow suit.

Up to ten groups of test data are visualized as curves, which are clear at a glance for players.

SkyCharger app Control

The charger has a built-in Bluetooth 5.0 module, allowing users to easily control the D200neo charger and analyze the battery through the SkyCharger app. Even when you are racing outside, you can test and check the battery performance curve anytime and anywhere.

Scan the QR code below to download the SkyCharger app.



DC Power

1. On the main interface, hold the Scroll button for three seconds to enter the system setting.
2. Select the option of DC Power, then adjust the output voltage and current.
3. Press Scroll to activate the power function after setting up.
4. Connect your desired DC equipment.

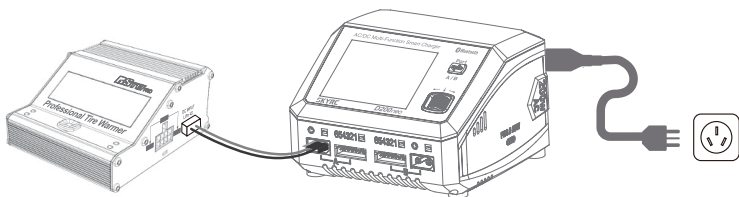

Notice:

- On the DC Power interface, press the Port button to switch A/B ports;
- On the main interface, press the Scroll button to exit the DC Power function;

PCH-150 Power & Charging Hub

The PD Charging Board can power several mobile devices simultaneously with the output power up to 100 watts when connecting with the charger.

Press and hold the Scroll button for three seconds to enter the system setting, select the Power for PD Hub-B menu and short press the Scroll button to activate it.

Connect the mobile devices to Port B after activated.

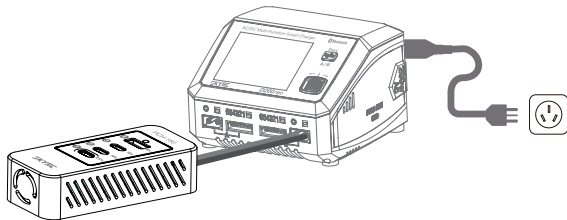

Notice:

- Short press the Scroll button to exit the power function.
- PCH-150 Power & Charging Hub is not included and must be purchased separately.
- Power for PD-Hub is only available on port B.

USB Type-C PD/QC3.0 Output

The charger can not only charge the R/C battery but also charge the mobile devices through the USB Type-C PD/QC3.0 output with a charging power of up to 20W.

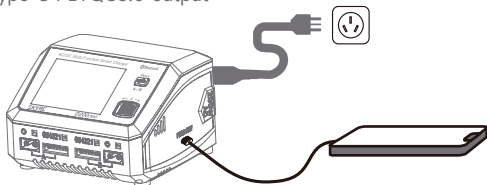

Get to know BumpGo

BumpGo is a technology in which SkyRC incorporates NFC tags to transform how you charge.

Tap the NFC tag onto the charger, click to confirm, and go!

It's that easy.

How to use BumpGo tag on batteries with D200neo+?

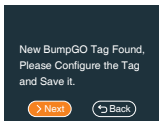
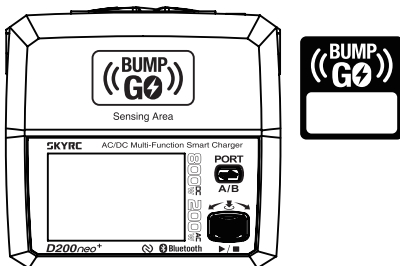

Step 1:

Tap a new BumpGo tag onto the sensing area. A menu will appear; click 'Next' to go to the battery task window.

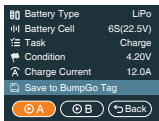

Step 2:

Set the desired parameters: battery type, cell, charge or discharge, cycle, charge current. please use the scrolling wheel to navigate to "Save to BumpGo Tag." and push the wheel to confirm.

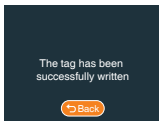

Step 3:

A menu will appear, instructing you to tap the BumpGo Tag near the sensing area of the charger. Hold the tag near the sensing area until you see "The tag has been successfully written."

How to Charge with the BumpGo tag?

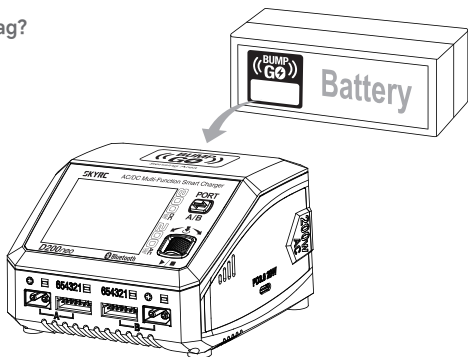

Step 1:

Tap the tag on the battery onto the sensing area of D200neo+. Ensure you place the tag in good contact with the sensing area on the charger.

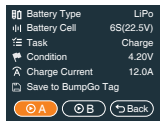

Step 2:

A menu will appear, displaying all the parameters stored in the tag.

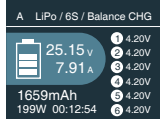







Step 3:

Select ports A or B, then press the wheel button to begin charging. Say goodbye to the hassles of adjusting various parameters.

* This feature is only available for D200neo NFC version.















Charging Settings













On the main interface, press the Scroll button to enter charging settings, in which you can switch A/B ports by pressing the Port button.

Menu	Definition
 Battery Type	Select your desired battery type. (LiPO, Lilon, LiFe, LiHV, Pb, NiMH, NiCd)
 Battery Cell	Select the number of battery cells corresponding to the battery type. (Li-xx: 1-6S, Ni-xx: 4-15S, Pb: 3S/6S/12S)
 Task	Select the program to be performed. (Balance CHG, Charge, Storage, Discharge, Parallel, etc.)
 Condition	Set the cut-off voltage as per the task.
 Current	Set the charge or discharge current.
 Start	Start the current program.
 Back	Back to the main interface.

System Setting

On the main interface, hold the Start button for seconds to enter the system setting.

Menu	Option	Definition
 Task Parameters	 Safety Timer	Customize a period for program protection.
	 Max.Capacity	Customize the protection of capacity.
	 Trickle Charge	Enable/disable trickle charge.
	 Back	Back to the previous interface.
 System Settings	 Language	Select your desired system language.
	 Max.Input Power	The maximum charge power. AC Input: 200W DC Input: 800W
	 Min.Input Voltage	In DC Input, set the minimum voltage for input protection.
	 LCD BackLight	Adjust the brightness of the screen.
	 Volume	Adjust the volume of the key and beep.
	 Completion Signal	Choose the way you'd like to be reminded when the program completes.
	 USB	Select the function of the USB Type-C port Auto: the charger detect the input of the USB port automatically Data: connect to PC Charge: charge the mobile devices
	 Back	Back to the previous interface.

Menu	Option	Definition
 DC Power (Press the port button to switch between port A/B)	 Voltage	Set the output voltage. (5.0-27.0V)
	 Current	Set the output current. (1.0-15.0V)
	 Start	Enable DC power output and return to the main interface.
	 Back	Back to the previous interface.
 Power for Tire Warmer- A	N/A	Activate to power SkyRC Tire Warmer on port A
 Power for PD Hub - B	N/A	Activate to power SkyRC PD Hub on Port B
 Battery Meter	N/A	Measure the battery voltage and internal resistance. (Switch A/B ports by pressing the Port button.)
 System Self-checking	N/A	N/A
 Factory Settings	N/A	Restore to the factory settings.
 System Info	N/A	Check the current system status.
 System Upgrade	N/A	Upgrade the system.
 Back	N/A	Back to the previous interface.

Errors and Warnings

In the event of a fault, the charger will display an error message and sound an alarm.

Error Message	Explanation
Error: DC Input Low!	DC input voltage is lower than preset!
Error: DC Input High!	DC input voltage is higher than preset!
Error: Battery Break!	The battery may be broken!
Cell Error	The cells do not match.
Battery Type Error!	The battery type is wrong!
Error: Overcharge!	The battery is overcharged!
Error: Over Time!	The program is timed out!
Error: Internal Temp. Too High!	The internal temperature is high!
Error: Battery Temp. Too High!	The battery temperature is high!
Error: Over Load!	The charger is overloaded!
Error: Reversed Polarity	The battery connection is reversed.
Error: Fully Charged	The battery is fully charged already!
Error: Outlet Overload	The output is overloaded.
Error: Balance Connection Break	The balance connection disconnects.
Error: Cell Volt Diff.	The voltage difference between each cell is high.
Error: AC to DC Too Low!	The input voltage is too low.
Error: Power Setting Error	The DC power setting is incorrect.

Firmware Upgrade Notice

To recover from a firmware upgrade failure, please follow these steps:

1. Press and hold the Scroll button, then connect the power cord; D200neo will power on with a blue screen notice.
2. Connect D200neo to your computer via a Type-C USB cable;
3. Launch the Charger Master on your computer;
4. When the status shows CONNECTED, click to check for new firmware;
5. Click to upgrade after detecting a new firmware;
6. Wait for the progress bar to finish and reach 100%; The process takes about 5 minutes.

Optional Parts



BD350 Discharger
SK-600147-01

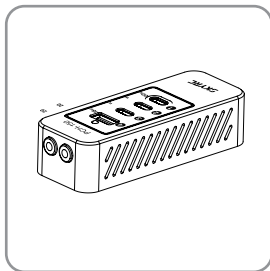

PCH-150 Charging Board
SK-600148-01

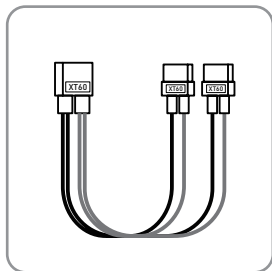

Parallel Charging Cable
SK-600023-19

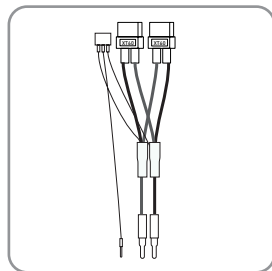

Pro Parallel Charging Cable
SK-600023-20

Conformity Declaration

FCC Caution:

Any changes or modifications not expressly approved by the party responsible for compliance could void the user's authority to operate this device.

This device complies with Part 15 of the FCC Rules. Operation is subject to the following two conditions: (1) This device may not cause harmful interference, and (2) this device must accept any interference received, including interference that may cause undesired operation.

Note:

This device has been tested and found to comply with the limits for a Class B digital device, according to part 15 of the FCC Rules. These limits are designed to provide reasonable protection against harmful interference in a residential installation. This device generates, uses, and can radiate radio frequency energy and, if not installed and used following the instructions, may cause harmful interference to radio communications. However, there is no guarantee that interference will not occur in a particular installation.

If this device does cause harmful interference to radio or television reception, which can be determined by turning the device off and on, the user is encouraged to try to correct the interference by one or more of the following measures:

- Reorient or relocate the receiving antenna.
- Increase the separation between the device and receiver.
- Connect the device to an outlet on a circuit different from that to which the receiver is connected.
- Consult the dealer or an experienced radio/TV technician for help.

Radiation Exposure Statement

This device complies with FCC radiation exposure limits set forth for an uncontrolled rolled environment. This device should be installed and operated with a minimum distance of 20cm between the radiator and your body.

Warranty and Service

Liability Exclusion

This charger is designed and approved exclusively for use with the types of battery stated in this Instruction Manual. SkyRC accepts no liability of any kind if the charger is used for any purpose other than that stated. We are unable to ensure that you follow the instructions supplied with the charger, and we have no control over the methods you employ for using, operating, and maintaining the device. For this reason, we are obliged to deny all liability for loss, damage, or costs that are incurred due to the incompetent or incorrect use and operation of our products, or which are connected with such operation in any way. Unless otherwise prescribed by law, our obligation to pay compensation, regardless of the legal argument employed, is limited to the invoice value of those SkyRC products which were immediately and directly involved in the event in which the damage occurred.

Warranty and Service

We guarantee this product to be free of manufacturing and assembly defects for a period of one year from the time of purchase. The warranty only applies to material or operational defects, which are present at the time of purchase. During that period, we will repair or replace free of service charge for products deemed defective due to those causes.

This warranty is not valid for any damage or subsequent damage arising as a result of misuse, modification, or as a result of failure to observe the procedures outlined in this manual.

Note:

The warranty service is valid in China only.

If you need warranty service overseas, please contact your dealer in the first instance, who is responsible for processing guarantee claims overseas. Due to high shipping costs, and complicated custom clearance procedures to send back to China, please understand that SkyRC can't provide warranty service to overseas end users directly.

If you have any questions which are not mentioned in the manual, please feel free to send an email to info@skycrc.com

SKYRC

The manual is subject to change without notice;
please refer to our website for the latest version!

Manufactured by
SKYRC TECHNOLOGY CO., LTD.
www.skyrc.com

© 2022 SkyRC Trchnology Co., Ltd. All Rights Reserved



[Version 1.2]