

MATEKSYS PDB FCHUB-12S

QUICK START GUIDE

LAYOUT

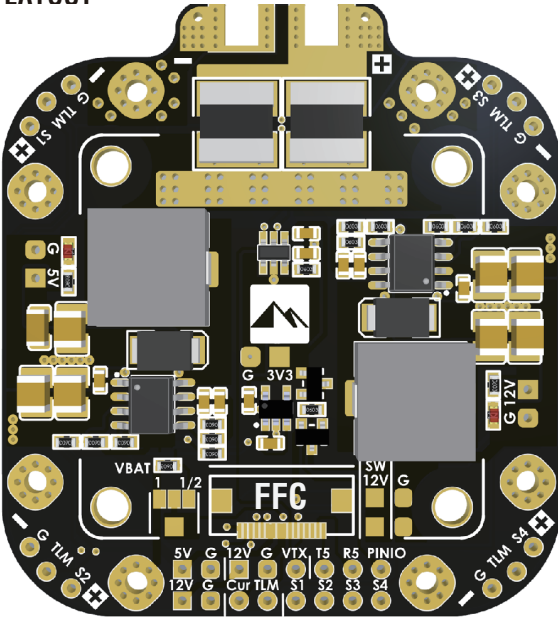

+ & - : LiPO & ESC power pads
8~60V (3~12S)

PDB: 4x70A cont. 4x110A burst.
5V: BEC 5V, 5A cont. 6A burst
12V: BEC 12V, 4A cont. 5A burst
3V3: LDO3.3V 500mA cont.
G: Ground

S1/S2/S3/S4: ESC signal
TLM: for BLheli32 ESC telemetry,
5x TLM pads are all shorted together

Curr: current sensor signal, 440A range, scale **75**



*** Following pads are used for MATEKSYS FC via FFC
VTX: Video transmitter signal
T5: UART5_TX on F405-STD/F722-STD
R5: UART5_RX on F405-STD/F722-STD

VBAT Applications

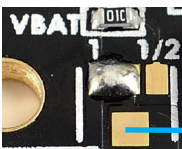

3~8S Battery
Bridge middle & left pads

= Battery voltage
It can be connected to FC for voltage detection and power supplier
Use FC default voltage scale, e.g.110 on MATEKSYS FC STD series

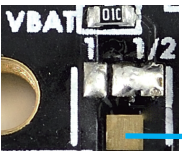
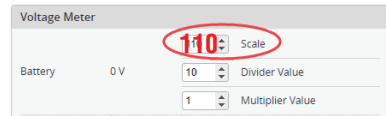

9~12S Battery, Flight controller MUST has no board 5V regulator !!!
Bridge middle & right pads

Use for FC voltage detection only
Voltage meter scale 210 on MATEKSYS FC STD series

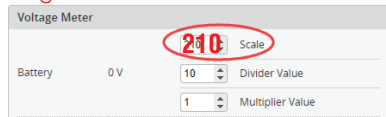

7~12S Battery, Flight controller has on board 5V regulator
If the onboard regulator doesn't support 7~12S input
Power your FC via 12V pad
FC can't detect battery voltage

SW12V & PINIO

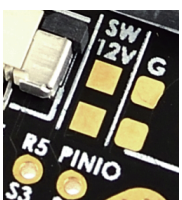

No output on **SW12V** pad by default if PINIO is not enabled

Any unused RX/TX/motor/PWM pad can be used for PINIO
e.g. connect PINIO pad to R5 of F405-STD/F722-STD

CLI [resource](#) to locate RX5 pin name
RX5 pad is **D02**
then

```
resource SERIAL_RX 5 none
resource PINIO 1 D02
set pinio_box = 40
save
```

```
resource MOTOR 5 A15
resource MOTOR 6 A08
resource MOTOR 7 B08
resource PPM 1 A03
resource PWM 1 A00
resource PWM 2 A01
resource PWM 3 A02
resource LED_STRIP 1 B06
resource SERIAL_TX 1 A09
resource SERIAL_TX 2 A02
resource SERIAL_TX 3 C10
resource SERIAL_TX 4 A00
resource SERIAL_TX 5 C12
resource SERIAL_RX 1 A10
resource SERIAL_RX 2 A03
resource SERIAL_RX 3 C11
resource SERIAL_RX 4 A01
resource SERIAL_RX 5 D02
```

Go to modes tab and assign an AUX channel to the USER1 mode. Click **SAVE**.
Flip the switch and test

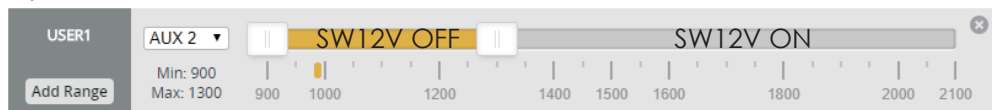

Wiring with MATEKSYS FC STD Series (FC has no onboard regulator)

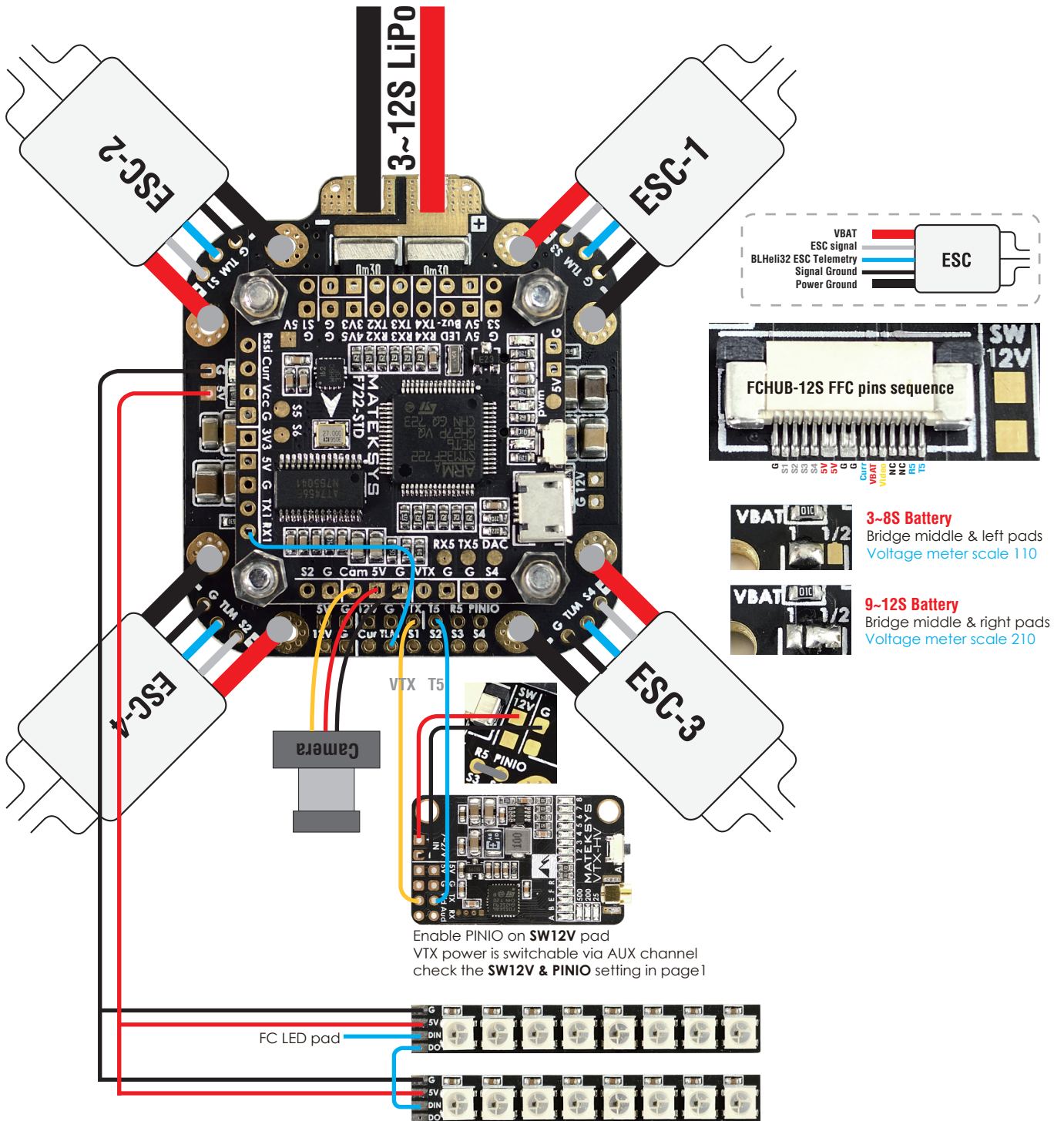

Wiring with MATEKSYS F722-mini (FC has on board 5V regulator)

